

RF Power Field Effect Transistor

N-Channel Enhancement-Mode Lateral MOSFET

Designed for broadband commercial and industrial applications with frequencies up to 1000 MHz. The high gain and broadband performance of this device make it ideal for large-signal, common-source amplifier applications in 26 volt base station equipment.

- Typical Two-Tone Performance at 945 MHz, 26 Volts
 - Output Power — 30 Watts PEP
 - Power Gain — 19 dB
 - Efficiency — 41.5%
 - IMD — -32.5 dBc
- Capable of Handling 10:1 VSWR, @ 26 Vdc, 945 MHz, 30 Watts CW Output Power

Features

- Integrated ESD Protection
- Designed for Maximum Gain and Insertion Phase Flatness
- Excellent Thermal Stability
- Characterized with Series Equivalent Large-Signal Impedance Parameters
- Low Gold Plating Thickness on Leads. L Suffix Indicates 40μ" Nominal.
- RoHS Compliant
- In Tape and Reel. R1 Suffix = 500 Units per 32 mm, 13 inch Reel.

MRF9030LSR1

**945 MHz, 30 W, 26 V
 LATERAL N-CHANNEL
 BROADBAND
 RF POWER MOSFET**

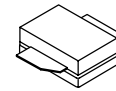

**CASE 360C-05, STYLE 1
 NI-360S**

ARCHIVE INFORMATION

ARCHIVE INFORMATION

Table 1. Maximum Ratings

Rating	Symbol	Value	Unit
Drain-Source Voltage	V_{DSS}	- 0.5, +68	Vdc
Gate-Source Voltage	V_{GS}	- 0.5, +15	Vdc
Total Device Dissipation @ $T_C = 25^\circ\text{C}$ Derate above 25°C	P_D	117 0.67	W W/°C
Storage Temperature Range	T_{stg}	- 65 to +150	°C
Case Operating Temperature	T_C	150	°C
Operating Junction Temperature	T_J	200	°C

Table 2. Thermal Characteristics

Characteristic	Symbol	Value	Unit
Thermal Resistance, Junction to Case	$R_{\theta JC}$	1.5	°C/W

Table 3. ESD Protection Characteristics

Test Conditions	Class
Human Body Model	1 (Minimum)
Machine Model	M1 (Minimum)

Table 4. Electrical Characteristics ($T_C = 25^\circ\text{C}$ unless otherwise noted)

Characteristic	Symbol	Min	Typ	Max	Unit
Off Characteristics					
Zero Gate Voltage Drain Leakage Current ($V_{DS} = 68\text{ Vdc}$, $V_{GS} = 0\text{ Vdc}$)	I_{DSS}	—	—	10	μAdc
Zero Gate Voltage Drain Leakage Current ($V_{DS} = 26\text{ Vdc}$, $V_{GS} = 0\text{ Vdc}$)	I_{DSS}	—	—	1	μAdc
Gate-Source Leakage Current ($V_{GS} = 5\text{ Vdc}$, $V_{DS} = 0\text{ Vdc}$)	I_{GSS}	—	—	1	μAdc
On Characteristics					
Gate Threshold Voltage ($V_{DS} = 10\text{ Vdc}$, $I_D = 100\ \mu\text{Adc}$)	$V_{GS(th)}$	2	2.9	4	Vdc
Gate Quiescent Voltage ($V_{DS} = 26\text{ Vdc}$, $I_D = 250\text{ mAdc}$)	$V_{GS(Q)}$	—	3.8	—	Vdc
Drain-Source On-Voltage ($V_{GS} = 10\text{ Vdc}$, $I_D = 0.7\text{ Adc}$)	$V_{DS(on)}$	—	0.19	0.4	Vdc
Forward Transconductance ($V_{DS} = 10\text{ Vdc}$, $I_D = 2\text{ Adc}$)	g_{fs}	—	3	—	S
Dynamic Characteristics					
Input Capacitance ($V_{DS} = 26\text{ Vdc} \pm 30\text{ mV(rms)ac}$ @ 1 MHz, $V_{GS} = 0\text{ Vdc}$)	C_{iss}	—	49.5	—	pF
Output Capacitance ($V_{DS} = 26\text{ Vdc} \pm 30\text{ mV(rms)ac}$ @ 1 MHz, $V_{GS} = 0\text{ Vdc}$)	C_{oss}	—	26.5	—	pF
Reverse Transfer Capacitance ($V_{DS} = 26\text{ Vdc} \pm 30\text{ mV(rms)ac}$ @ 1 MHz, $V_{GS} = 0\text{ Vdc}$)	C_{rss}	—	1	—	pF

(continued)

Table 4. Electrical Characteristics ($T_C = 25^\circ\text{C}$ unless otherwise noted) (continued)

Characteristic	Symbol	Min	Typ	Max	Unit
Functional Tests (In Freescale Test Fixture, 50 ohm system)					
Two-Tone Common-Source Amplifier Power Gain ($V_{DD} = 26\text{ Vdc}$, $P_{out} = 30\text{ W PEP}$, $I_{DQ} = 250\text{ mA}$, $f_1 = 945.0\text{ MHz}$, $f_2 = 945.1\text{ MHz}$)	G_{ps}	18	19	—	dB
Two-Tone Drain Efficiency ($V_{DD} = 26\text{ Vdc}$, $P_{out} = 30\text{ W PEP}$, $I_{DQ} = 250\text{ mA}$, $f_1 = 945.0\text{ MHz}$, $f_2 = 945.1\text{ MHz}$)	η	37	41.5	—	%
3rd Order Intermodulation Distortion ($V_{DD} = 26\text{ Vdc}$, $P_{out} = 30\text{ W PEP}$, $I_{DQ} = 250\text{ mA}$, $f_1 = 945.0\text{ MHz}$, $f_2 = 945.1\text{ MHz}$)	IMD	—	-32.5	-28	dBc
Input Return Loss ($V_{DD} = 26\text{ Vdc}$, $P_{out} = 30\text{ W PEP}$, $I_{DQ} = 250\text{ mA}$, $f_1 = 945.0\text{ MHz}$, $f_2 = 945.1\text{ MHz}$)	IRL	—	-15.5	-9	dB
Two-Tone Common-Source Amplifier Power Gain ($V_{DD} = 26\text{ Vdc}$, $P_{out} = 30\text{ W PEP}$, $I_{DQ} = 250\text{ mA}$, $f_1 = 930.0\text{ MHz}$, $f_2 = 930.1\text{ MHz}$ and $f_1 = 960.0\text{ MHz}$, $f_2 = 960.1\text{ MHz}$)	G_{ps}	—	19	—	dB
Two-Tone Drain Efficiency ($V_{DD} = 26\text{ Vdc}$, $P_{out} = 30\text{ W PEP}$, $I_{DQ} = 250\text{ mA}$, $f_1 = 930.0\text{ MHz}$, $f_2 = 930.1\text{ MHz}$ and $f_1 = 960.0\text{ MHz}$, $f_2 = 960.1\text{ MHz}$)	η	—	41.5	—	%
3rd Order Intermodulation Distortion ($V_{DD} = 26\text{ Vdc}$, $P_{out} = 30\text{ W PEP}$, $I_{DQ} = 250\text{ mA}$, $f_1 = 930.0\text{ MHz}$, $f_2 = 930.1\text{ MHz}$ and $f_1 = 960.0\text{ MHz}$, $f_2 = 960.1\text{ MHz}$)	IMD	—	-33	—	dBc
Input Return Loss ($V_{DD} = 26\text{ Vdc}$, $P_{out} = 30\text{ W PEP}$, $I_{DQ} = 250\text{ mA}$, $f_1 = 930.0\text{ MHz}$, $f_2 = 930.1\text{ MHz}$ and $f_1 = 960.0\text{ MHz}$, $f_2 = 960.1\text{ MHz}$)	IRL	—	-14	—	dB
Power Output, 1 dB Compression Point ($V_{DD} = 26\text{ Vdc}$, $P_{out} = 30\text{ W CW}$, $I_{DQ} = 250\text{ mA}$, $f_1 = 945.0\text{ MHz}$)	P_{1dB}	—	30	—	W
Common-Source Amplifier Power Gain ($V_{DD} = 26\text{ Vdc}$, $P_{out} = 30\text{ W CW}$, $I_{DQ} = 250\text{ mA}$, $f_1 = 945.0\text{ MHz}$)	G_{ps}	—	19	—	dB
Drain Efficiency ($V_{DD} = 26\text{ Vdc}$, $P_{out} = 30\text{ W CW}$, $I_{DQ} = 250\text{ mA}$, $f_1 = 945.0\text{ MHz}$)	η	—	60	—	%

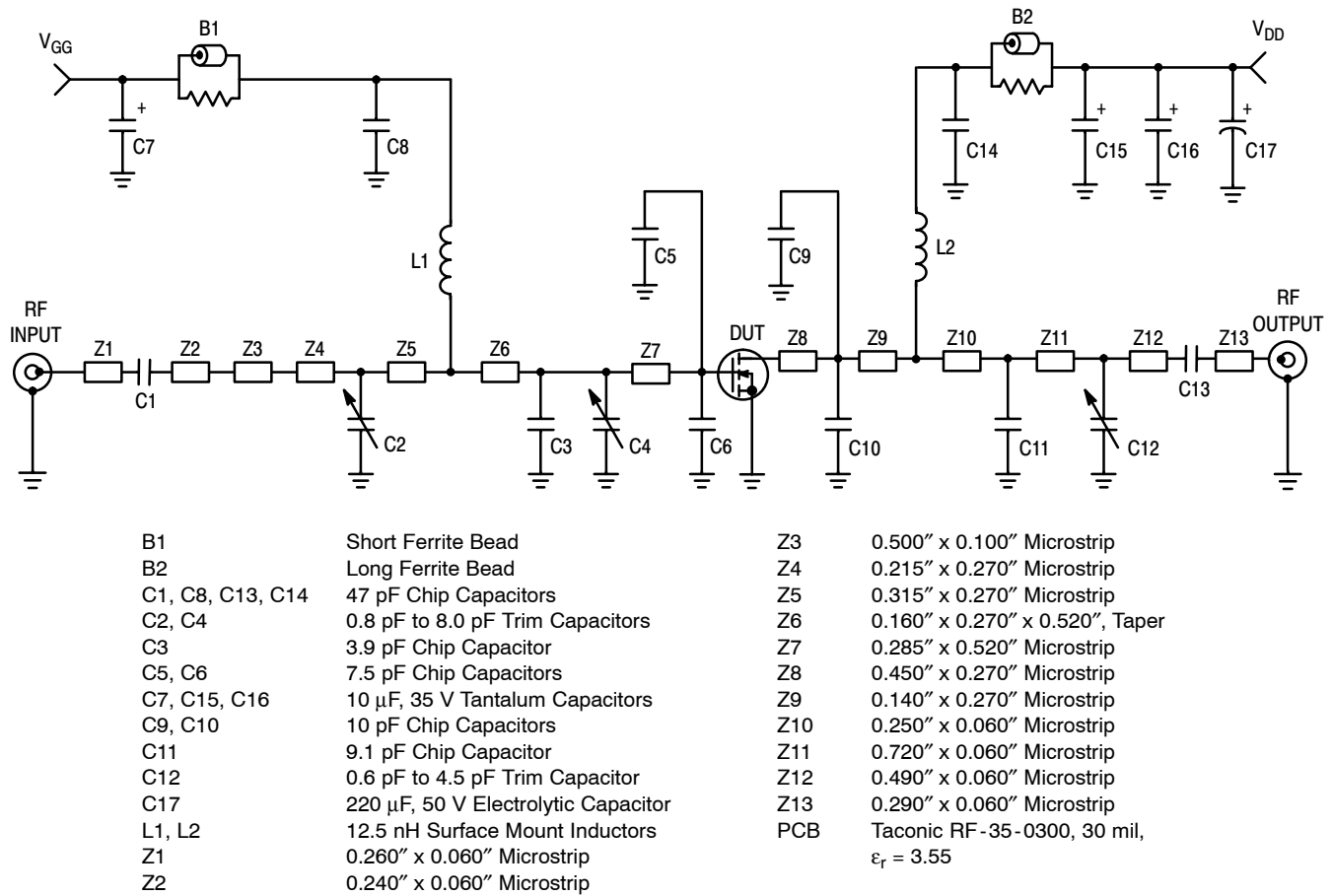
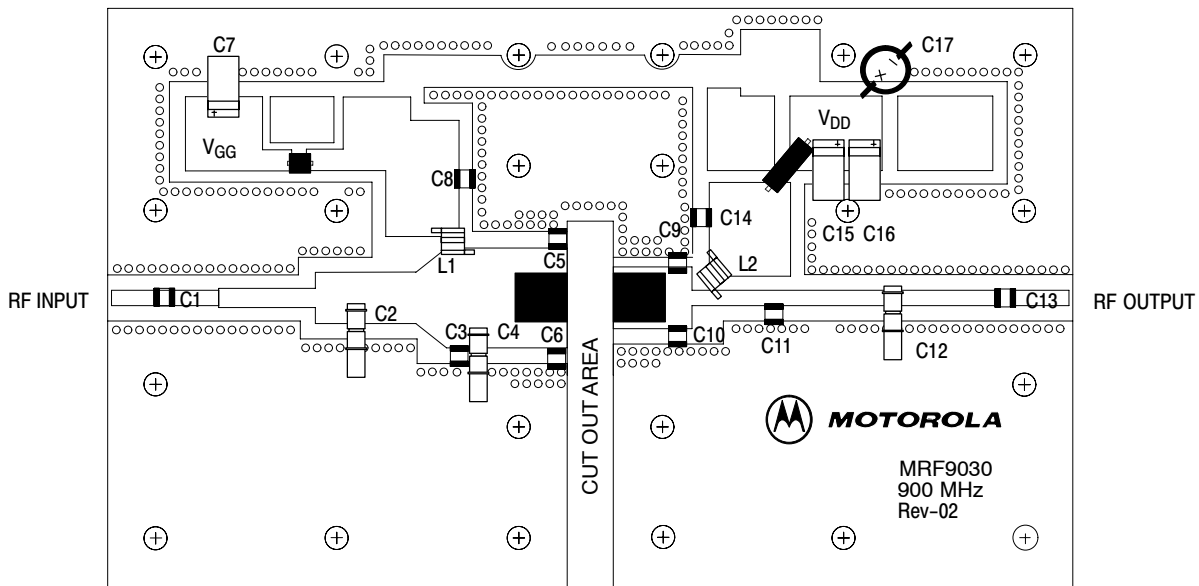

Figure 1. 945 MHz Broadband Test Circuit Schematic



Freescale has begun the transition of marking Printed Circuit Boards (PCBs) with the Freescale Semiconductor signature/logo. PCBs may have either Motorola or Freescale markings during the transition period. These changes will have no impact on form, fit or function of the current product.

Figure 2. 945 MHz Broadband Test Circuit Component Layout

TYPICAL CHARACTERISTICS

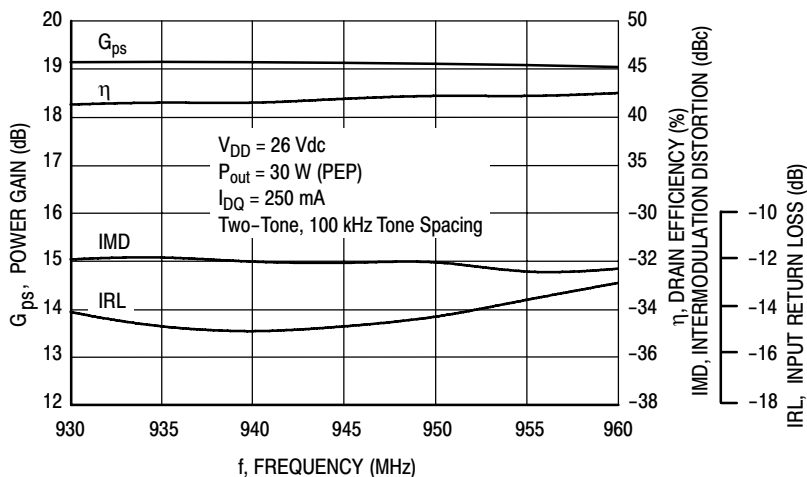

Figure 3. Class AB Broadband Circuit Performance

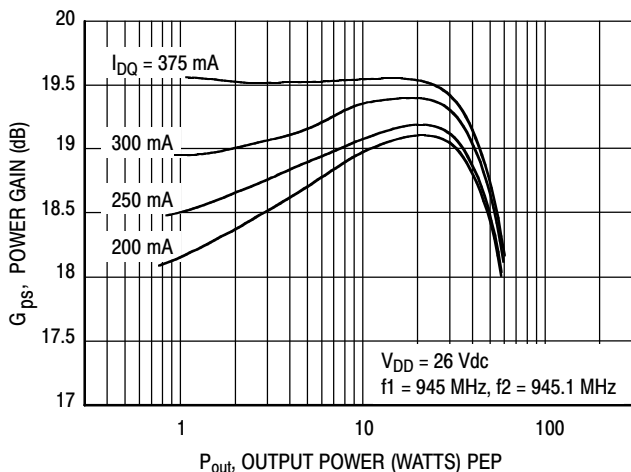

Figure 4. Power Gain versus Output Power

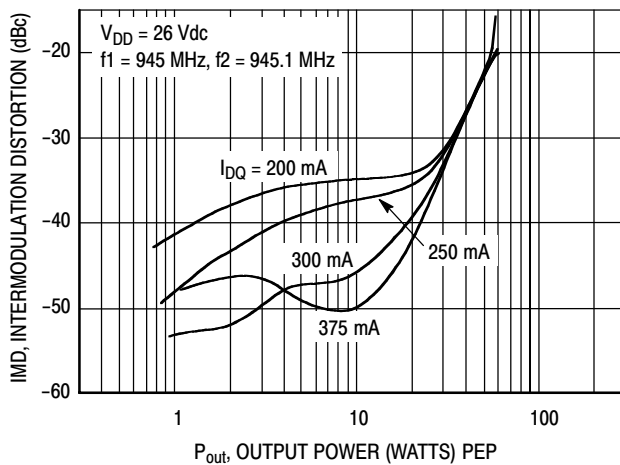

Figure 5. Intermodulation Distortion versus Output Power

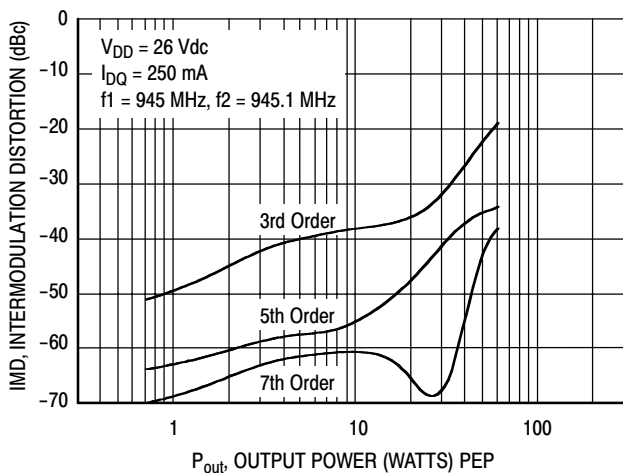

Figure 6. Intermodulation Distortion Products versus Output Power

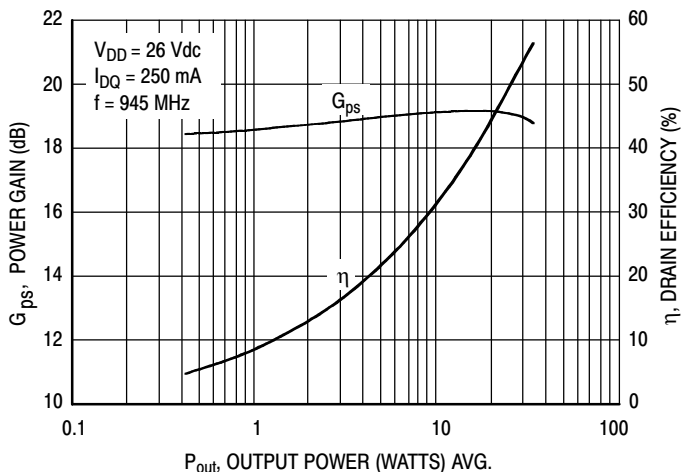

Figure 7. Power Gain and Efficiency versus Output Power

ARCHIVE INFORMATION

ARCHIVE INFORMATION

TYPICAL CHARACTERISTICS

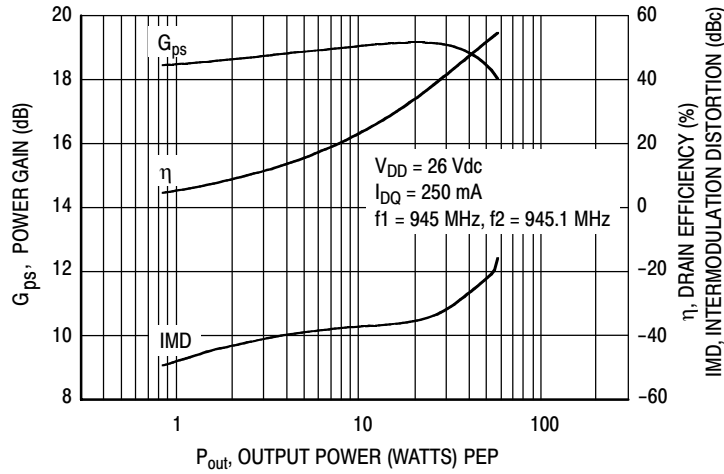
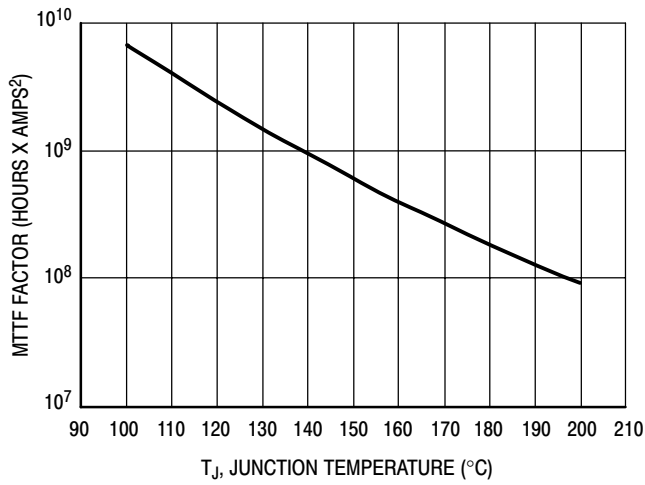
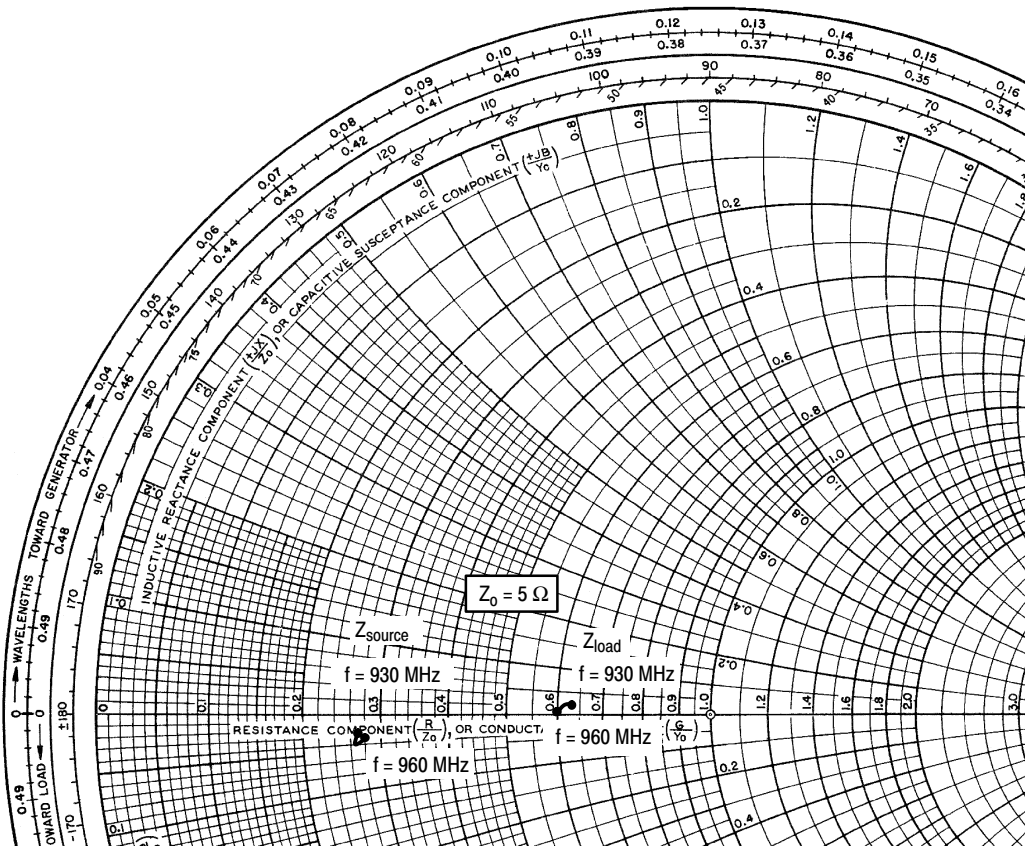

Figure 8. Power Gain, Efficiency and IMD versus Output Power



This above graph displays calculated MTTF in hours \times ampere^2 drain current. Life tests at elevated temperatures have correlated to better than $\pm 10\%$ of the theoretical prediction for metal failure. Divide MTTF factor by I_D^2 for MTTF in a particular application.

Figure 9. MTTF Factor versus Junction Temperature



$V_{DD} = 26\text{ V}$, $I_{DQ} = 250\text{ mA}$, $P_{out} = 30\text{ W PEP}$

f MHz	Z_{source} Ω	Z_{load} Ω
930	$1.34 - j0.1$	$3.175 + j0.09$
945	$1.36 - j0.2$	$3.1 + j0.08$
960	$1.4 - j0.14$	$3.0 + j0.05$

Z_{source} = Test circuit impedance as measured from gate to ground.

Z_{load} = Test circuit impedance as measured from drain to ground.

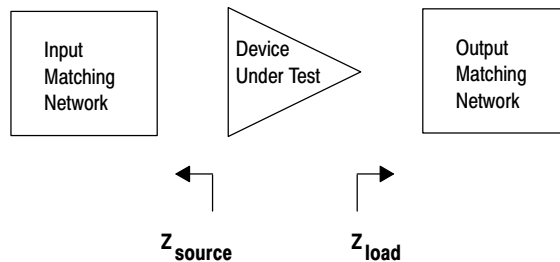
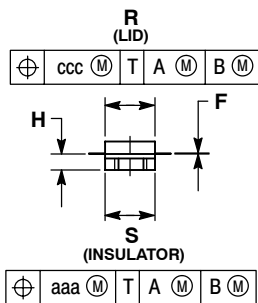
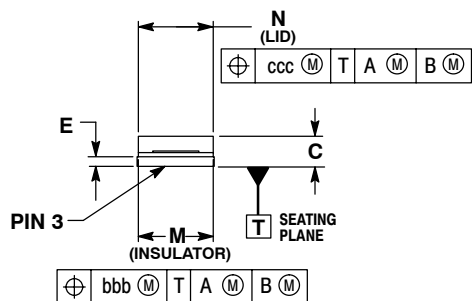
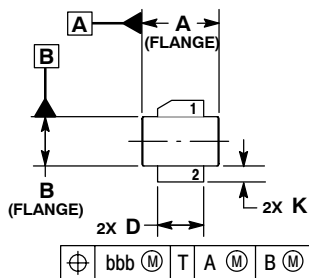

Figure 10. Series Equivalent Source and Load Impedance

PACKAGE DIMENSIONS



- NOTES:
1. INTERPRET DIMENSIONS AND TOLERANCES PER ASME Y14.5M-1994.
 2. CONTROLLING DIMENSION: INCH.
 3. DIMENSION H IS MEASURED 0.030 (0.762) AWAY FROM PACKAGE BODY.

DIM	INCHES		MILLIMETERS	
	MIN	MAX	MIN	MAX
A	0.375	0.385	9.53	9.78
B	0.225	0.235	5.72	5.97
C	0.105	0.155	2.67	3.94
D	0.210	0.220	5.33	5.59
E	0.035	0.045	0.89	1.14
F	0.004	0.006	0.10	0.15
H	0.057	0.067	1.45	1.70
K	0.085	0.115	2.16	2.92
M	0.355	0.365	9.02	9.27
N	0.357	0.363	9.07	9.22
R	0.227	0.23	5.77	5.92
S	0.225	0.235	5.72	5.97
aaa	0.005 REF		0.13 REF	
bbb	0.010 REF		0.25 REF	
ccc	0.015 REF		0.38 REF	

- STYLE 1:
- PIN 1. DRAIN
 - GATE
 - SOURCE

**CASE 360C-05
ISSUE E
NI-360S
MRF9030LSR1**

ARCHIVE INFORMATION

ARCHIVE INFORMATION

REVISION HISTORY

The following table summarizes revisions to this document.

Revision	Date	Description
7	Sept. 2008	<ul style="list-style-type: none">• Data sheet revised to reflect part status change, p. 1, including use of applicable overlay.• Data sheet archived. Parts no longer manufactured.• Added Revision History, p. 9

ARCHIVE INFORMATION

ARCHIVE INFORMATION

How to Reach Us:**Home Page:**

www.freescale.com

Web Support:

<http://www.freescale.com/support>

USA/Europe or Locations Not Listed:

Freescale Semiconductor, Inc.
Technical Information Center, EL516
2100 East Elliot Road
Tempe, Arizona 85284
1-800-521-6274 or +1-480-768-2130
www.freescale.com/support

Europe, Middle East, and Africa:

Freescale Halbleiter Deutschland GmbH
Technical Information Center
Schatzbogen 7
81829 Muenchen, Germany
+44 1296 380 456 (English)
+46 8 52200080 (English)
+49 89 92103 559 (German)
+33 1 69 35 48 48 (French)
www.freescale.com/support

Japan:

Freescale Semiconductor Japan Ltd.
Headquarters
ARCO Tower 15F
1-8-1, Shimo-Meguro, Meguro-ku,
Tokyo 153-0064
Japan
0120 191014 or +81 3 5437 9125
support.japan@freescale.com

Asia/Pacific:

Freescale Semiconductor China Ltd.
Exchange Building 23F
No. 118 Jianguo Road
Chaoyang District
Beijing 100022
China
+86 10 5879 8000
support.asia@freescale.com

For Literature Requests Only:

Freescale Semiconductor Literature Distribution Center
P.O. Box 5405
Denver, Colorado 80217
1-800-441-2447 or +1-303-675-2140
Fax: +1-303-675-2150
LDCForFreescaleSemiconductor@hibbertgroup.com

Information in this document is provided solely to enable system and software implementers to use Freescale Semiconductor products. There are no express or implied copyright licenses granted hereunder to design or fabricate any integrated circuits or integrated circuits based on the information in this document.

Freescale Semiconductor reserves the right to make changes without further notice to any products herein. Freescale Semiconductor makes no warranty, representation or guarantee regarding the suitability of its products for any particular purpose, nor does Freescale Semiconductor assume any liability arising out of the application or use of any product or circuit, and specifically disclaims any and all liability, including without limitation consequential or incidental damages. "Typical" parameters that may be provided in Freescale Semiconductor data sheets and/or specifications can and do vary in different applications and actual performance may vary over time. All operating parameters, including "Typicals", must be validated for each customer application by customer's technical experts. Freescale Semiconductor does not convey any license under its patent rights nor the rights of others. Freescale Semiconductor products are not designed, intended, or authorized for use as components in systems intended for surgical implant into the body, or other applications intended to support or sustain life, or for any other application in which the failure of the Freescale Semiconductor product could create a situation where personal injury or death may occur. Should Buyer purchase or use Freescale Semiconductor products for any such unintended or unauthorized application, Buyer shall indemnify and hold Freescale Semiconductor and its officers, employees, subsidiaries, affiliates, and distributors harmless against all claims, costs, damages, and expenses, and reasonable attorney fees arising out of, directly or indirectly, any claim of personal injury or death associated with such unintended or unauthorized use, even if such claim alleges that Freescale Semiconductor was negligent regarding the design or manufacture of the part.

Freescale™ and the Freescale logo are trademarks of Freescale Semiconductor, Inc. All other product or service names are the property of their respective owners.

© Freescale Semiconductor, Inc. 2008. All rights reserved.

